

version .0

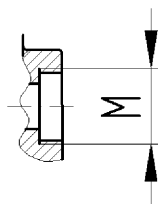
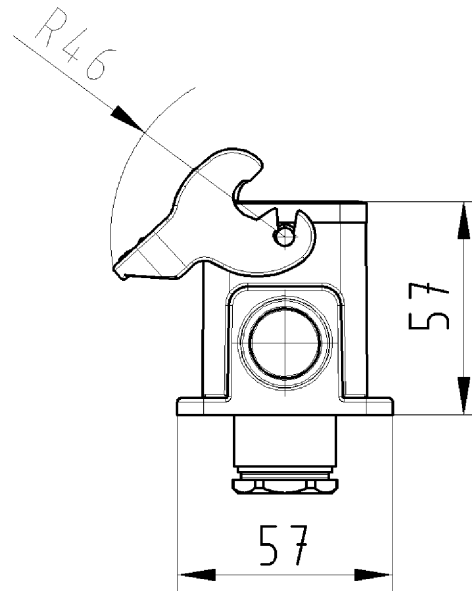
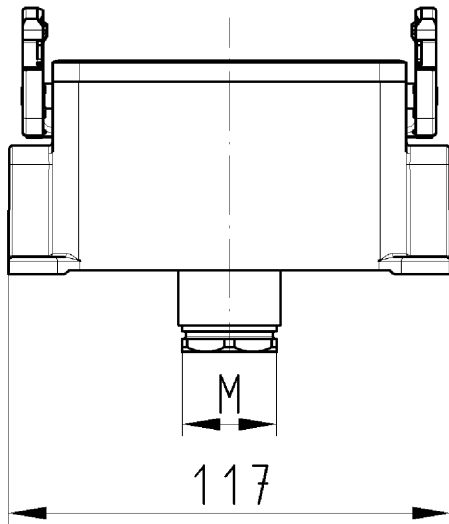

version .1

Gehäuseunterteil
71.333.1635.0

Zeichnungsnummer
71.333.1635.010W
Gehäuseunterteil

23.11.2007
Roppelt Dominik
M 1:1